

MIPRO[®]

User Guide

BC-100

Wireless Boundary Microphone

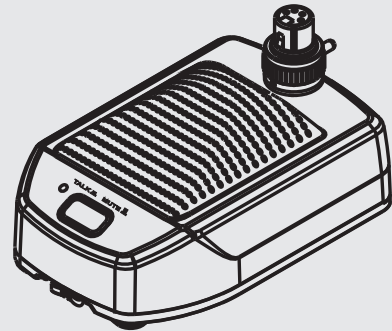

MIPRO[®]
MICROPHONE PROFESSIONALS

MIPRO Electronics Co., Ltd

Headquarters : 814 Pei-Kang Road, Chiayi, 60096, Taiwan
Tel : +886.5.238.0809 Fax : +886.5.238.0803
www.mipro.com.tw mipro@mipro.com.tw

All rights reserved. MN 015/11

Do not copy or forward without prior approvals MIPRO.

Specifications and design subject to change without notice.



2 CE560A

Contents

- 1 Controls and Indicators
- 3 Insert Bodypack Transmitter Steps
- 7 Charging Method
- 8 Operating Instructions for Wireless Boundary Microphone
- 10 Operating Instructions for external Gooseneck Microphone
- 13 Boundary Microphone Operating Instructions
- 14 Gooseneck Microphone Operating Instructions

Controls and Indicators

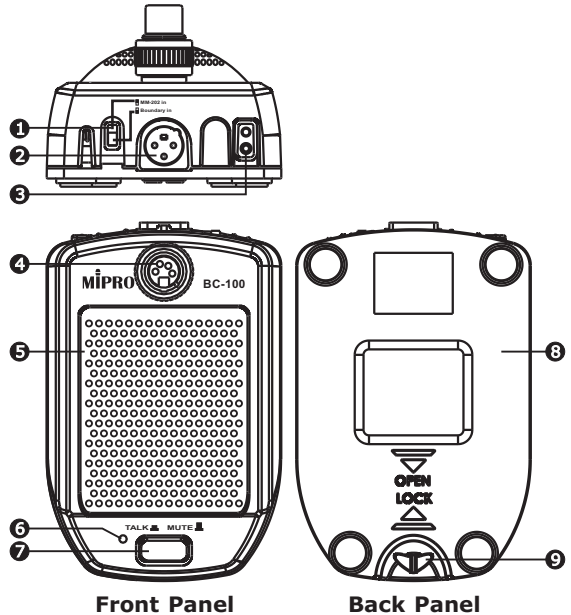

- 1 Microphone Selection Switch:** Boundary input or MM-202 input.
- 2 Balanced XLR Connector**
- 3 DC input & charging indicator:** Charging (red) ; Fully Charged (green). Indicator will not lid if rechargeable battery is polarity inserted incorrectly.
Note: Do not insert disposable type battery.

- ④ **Gooseneck Microphone Connector:** Accepts a MIPRO MM-204, MM-205, MM-206 gooseneck microphone.
- ⑤ **Microphone Grill:** Protects the internal unidirectional electric condenser microphone.
- ⑥ **TALK indicator:** When TALK/MUTE is switched to TALK the indicator will stay lid.
- ⑦ **Talk & Mute button:** Press to Talk (recessed =active); Press to Mute (up=muted).
- ⑧ **Bottom Cover:** To insert/remove bodypack transmitter or battery.
- ⑨ **Bottom Cover Lock:** Secure bottom cover in place.
- ⑩ **Bodypack Transmitter Fixed Swing Holder:** Secure bodypack transmitter in place.
- ⑪ **Contact Points:** Ensure the rechargeable contact points of bodypack transmitters are aligned here for effective charging.

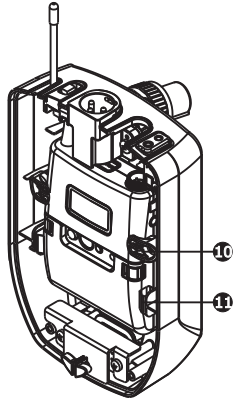

Insert Bodypack Transmitter Steps

1. Remove the detachable & reversible bodypack clip located at the back of MIPRO bodypack transmitter before insertion.

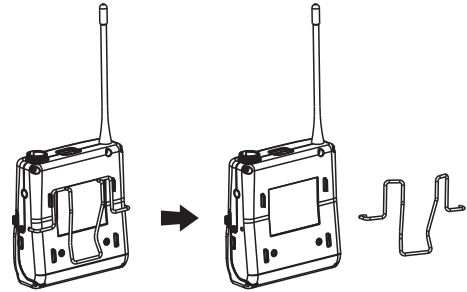

Wireless Boundary Microphone

2. Rotate 180 degrees and push down according to the arrow to open bottom cover.

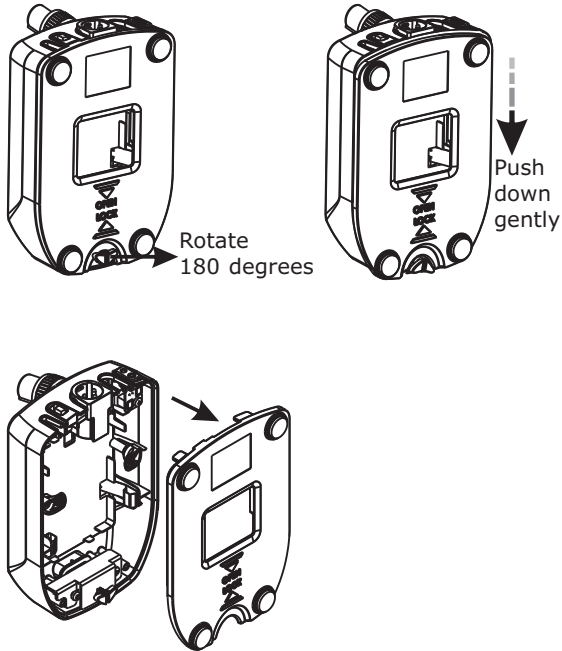

Wireless Boundary Microphone

3. Align and connect XLR connector to a MIPRO rechargeable bodypack transmitter before placing into the storage compartment.
- * Forcing the bodypack transmitter into the storage compartment with the reversible bodypack clip may not be fit or function properly or damage the storage compartment.

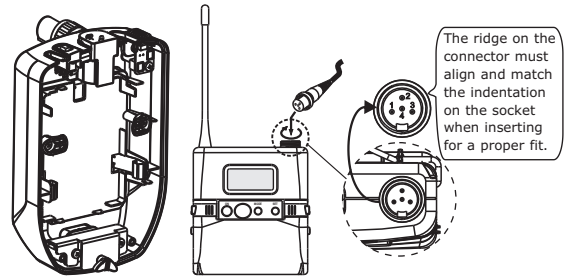

Wireless Boundary Microphone

4. Insert bodypack transmitter gently into slot and secure by turning the fixed swing holder.
5. Ensure transmitter contact points are aligned and push down for a secured fit.

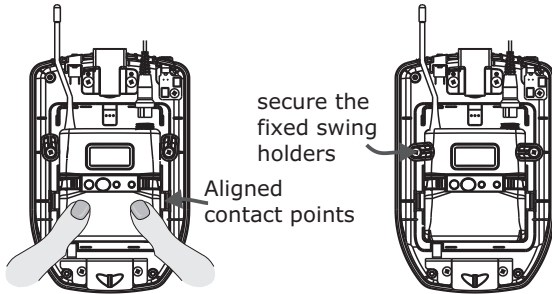

6. Cover up and secured with the bottom cover by turning the cover lock.

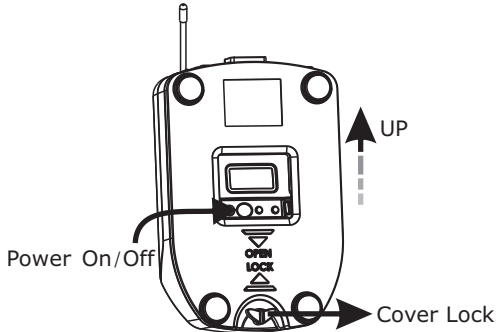

Wireless Boundary Microphone

Charging Method

Power off the transmitter before inserting the charger into an AC outlet.

- Charging (red indicator)
- Fully Charged (green indicator)
- If indicator is not lid, check to see if the rechargeable battery is inserted incorrect according to polarity.

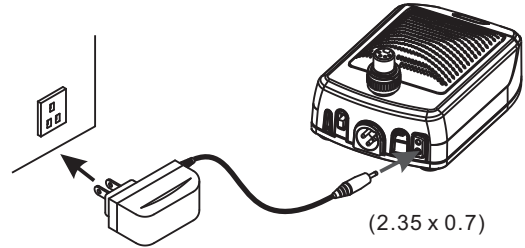

Caution

- Always use the supplied charger to charge the battery pack. power supply output 5V / 1A.
- Power off during charging.

Operating Instructions for Wireless Boundary Microphone

1. Ascertain a Gooseneck microphone is plugged-in prior to power on the transmitter to prevent noise interference.
2. Tighten the mechanical locking ring in a clockwise direction for a secured fit. (see diagram)
3. Unplug the microphone in a counter-clockwise direction.

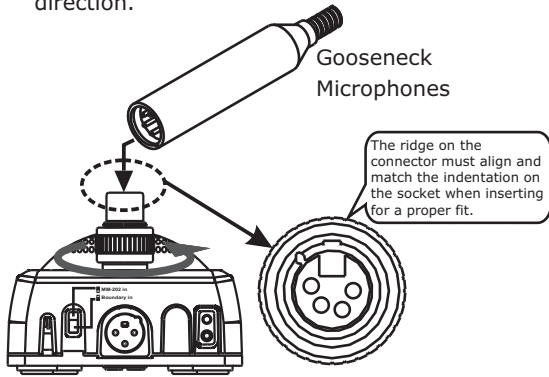

4. Align & connect XLR connector and place bodypack transmitter into the compartment.
5. Switch to Boundary input position.

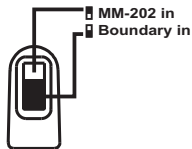

6. Power on the bodypack transmitter before switching to TALK mode. Indicator will lid during TALK mode. Speak into boundary microphone.
7. Push to Mute (up button).

Note: Always switch transmitter off when not in use for extended battery life. Remove the batteries if the transmitter is not to be used for a long period of time.

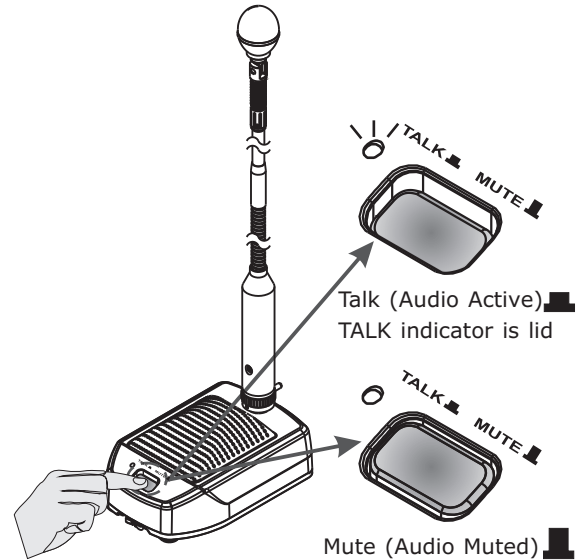

Operating Instructions for external Gooseneck Microphone

1. Align & connect XLR connector and place bodypack transmitter into the compartment
2. Switch to MM-202 input position.
3. Ensure the Talk/Mute button is at Mute position (up) before gooseneck microphone is inserted into the connector as shown to avoid the undesired noises.

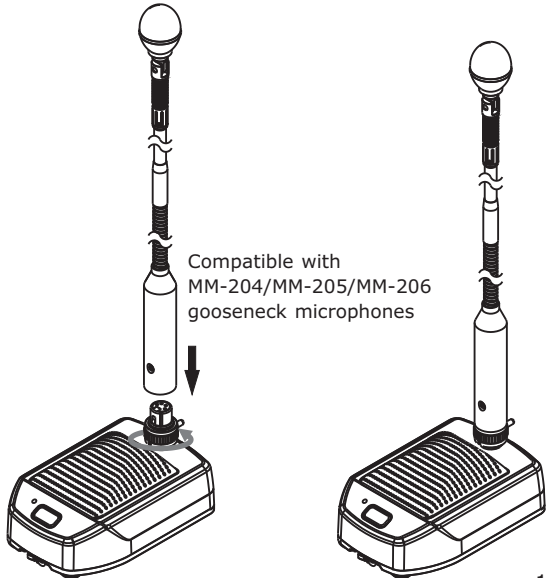
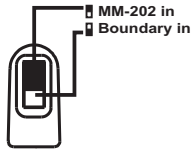

4. Power on the bodypack transmitter before switching to TALK mode. Indicator will lid during TALK mode. Speak into gooseneck microphone.
5. Push to Mute (up button).

Note: Always switch transmitter off when not in use for extended battery life. Remove the batteries if the transmitter is not to be used for a long period of time

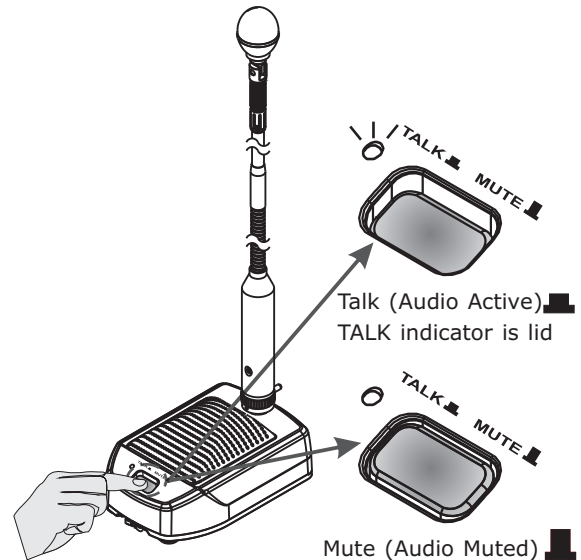

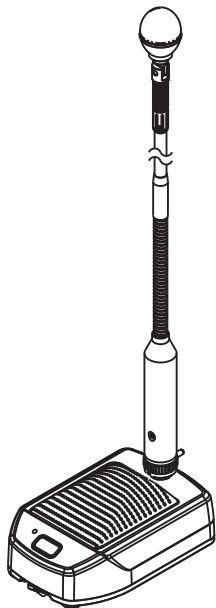

Installed with MM-204/
MM-205/MM-206 mic

* MM-204、MM-205、MM-206、ACT-32T、
ACT-32TC、ACT-52T、ACT-70T and ACT-70TC...
are sold separately.

Boundary Microphone Operating Instructions

1. Connect a XLR to XLR cable to each end.
2. Switch to "Boundary in" position at the back panel.

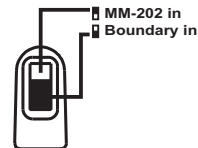

3. Press TALK to speak (lid indicator).
MUTE to mute (indicator is not lid).
4. Once XLR connector is connected to a
amplifier/mixer it provides 12V~48V DC
phantom power. Disconnect if XLR connector
will not be used for an extended period of time.

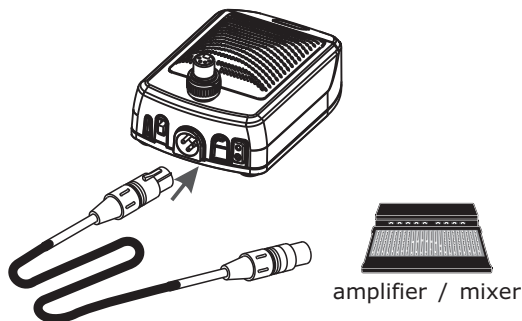

Gooseneck Microphone Operating Instructions

1. Connect a XLR to XLR cable to each end.
2. Switch to "MM-202 in" position at the back panel.

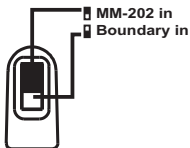

3. Press TALK to speak (lid indicator).
MUTE to mute (indicator is not lid).
4. Once XLR connector is connected to a amplifier/ mixer it provides 12V~48V DC phantom power.

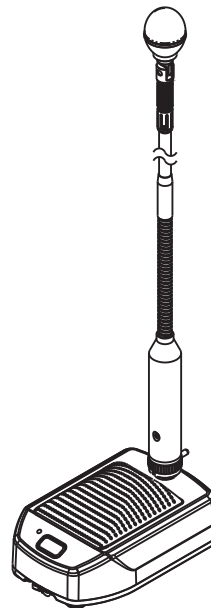
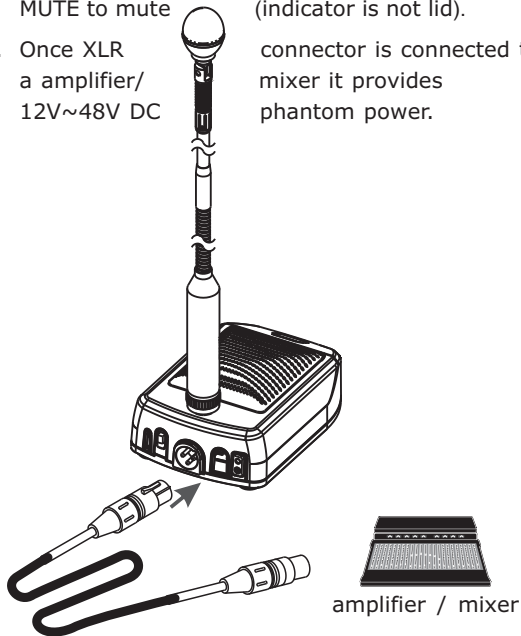

Installed with MM-204/
MM-205/MM-206 mic

- * MM-204 、 MM-205 、 MM-206 、 ACT-32T 、 ACT-32TC 、 ACT-52T 、 ACT-70T and ACT-70TC... are sold separately.

Notes

1. Refer to actual product in the event of product description discrepancy.
2. Frequency range and maximum deviation comply with the regulations of different countries.

Federal Communication Commission Interference Statement

This equipment has been tested and found to comply with the limits for a Class B digital device, pursuant to Part 15 of the FCC Rules. These limits are designed to provide reasonable protection against harmful interference in a residential installation. This equipment generates, uses and can radiate radio frequency energy and, if not installed and used in accordance with the instructions, may cause harmful interference to radio communications. However, there is no guarantee that interference will not occur in a particular installation. If this equipment does cause harmful interference to radio or television reception, which can be determined by turning the equipment off and on, the user is encouraged to try to correct the interference by one of the following measures:

- Reorient or relocate the receiving antenna.
- Increase the separation between the equipment and receiver.
- Connect the equipment into an outlet on a circuit different from that to which the receiver is connected.
- Consult the dealer or an experienced radio/TV technician for help.

FCC Caution: To assure continued compliance, any changes or modifications not expressly approved by the party responsible for compliance could void the user's authority to operate this equipment. (Example - use only shielded interface cables when connecting to computer or peripheral devices).

FCC Radiation Exposure Statement

This equipment complies with FCC RF radiation exposure limits set forth for an uncontrolled environment. This equipment should be installed and operated with a minimum distance of 0.5 cm between the radiator and your body.

This transmitter must not be co-located or operating in conjunction with any other antenna or transmitter. The antennas used for this transmitter must be installed to provide a separation distance of at least 0.5 cm from all persons and must not be co-located or operating in conjunction with any other antenna or transmitter.

This device complies with Part 15 of the FCC Rules. Operation is subject to the following two conditions:
(1) This device may not cause harmful interference, and
(2) This device must accept any interference received, including interference that may cause undesired operation.

IC



This device complies with Industry Canada RSS-210 ISSUE 2 standards. Operation is subject to the following two conditions:

- (1) this device may not cause interference, and
- (2) this device must accept any interference, including interference that may cause undesired operation of the device.

Le présent appareil est conforme aux CNR d'Industrie Canada applicables aux appareils radio exempts de licence. L'exploitation est autorisée aux deux conditions suivantes: (1) l'appareil ne doit pas produire de brouillage, et
(2) l'utilisateur de l'appareil doit accepter tout brouillage radioélectrique subi, même si le brouillage est susceptible d'en compromettre le fonctionnement.

WARNING

1. **FOR OUTDOOR USE:**
To reduce the risk of fire or electric shock, do not expose this apparatus to rain or moisture.
2. **UNDER WET LOCATION:**
Apparatus should not be exposed to dripping or splashing and no objects filled with liquids, such as vases should be placed on the apparatus.
3. **SERVICE INSTRUCTIONS:**
CAUTION - These servicing instructions are for use by qualified service personnel only. To reduce the risk of electric shock, do not perform any servicing other than that contained in the operating instructions unless you are qualified to do so.

**CAUTION**
RISK OF ELECTRIC SHOCK
DO NOT OPEN

 This symbol indicates that dangerous voltage constituting a risk of electric shock is present within this unit.

 This symbol indicates that there are important operating and maintenance instructions in the literature accompanying this unit.

Disposal Dispose of any unusable devices or batteries responsibly and in accordance with any applicable regulations.



2005-08-18

Disposing of used batteries with domestic waste is to be avoided!

Batteries / NiCad cells often contain heavy metals such as cadmium(Cd), mercury(Hg) and lead(Pb) that makes them unsuitable for disposal with domestic waste. You may return spent batteries/accumulators free of charge to recycling centres or anywhere else batteries/accumulators are sold.

By doing so, you contribute to the conservation of our environment!